

VERSAFLAP

Modulo cablato integrato a scomparsa I
Built-in power/data module

SCHEDA TECNICA | DATA SHEET

ED.08_31.08.2023

VERSAFLAP

Modulo cablato integrato a scomparsa |
Built-in power/data module



DATI COMMERCIALI | COMMERCIAL DATA

Codice prodotto Product code	060.11	Codice famiglia di prodotto - Valido per tutte le configurazioni Family product code - Valid for all configurations
---------------------------------	--------	--

DATI TECNICI | TECHNICAL DATA

GENERALE | GENERAL



Tensione nominale Rated voltage	110 - 250 V ac, 50 Hz
Corrente nominale Rated current	10 - 16A
Grado di protezione Degree of protection	IP20
Ambiente di utilizzo Operating environment	Interno Indoor

MATERIALI | MATERIALS

Corpo Body	Alluminio Aluminium
Componenti assemblaggio Rated current	Tecnopolimero autoestinguente Flame retardant polymer
Prese elettriche Electric Sockets	Tecnopolimero autoestinguente Flame retardant polymer

PRESE ELETTRICHE | ELECTRIC SOCKETS

B - E - F - G - I - J - K - L - Univ, Unel, 2P+T, con otturatori (protezione bimbi)
B - E - F - G - I - J - K - L - Univ Unel, 2P+T, with shutters (child protection)

Tipo Type			
			
Voltaggio Rated voltage	220 - 250 V ac, 50 Hz	Preso tipo Socket type	E - F - G - P30 - UNEL - UNIV
	110 - 125 V ac, 60 Hz	Preso tipo Socket type	B - UNIV
Corrente Rated current	16 A	Preso tipo Socket type	E - F - K - L - P30 - UNEL
	15 A	Preso tipo Socket type	B
	13 A	Preso tipo Socket type	G
	10 A	Preso tipo Socket type	I - J - UNIV
	Carico massimo complessivo Max.load power	3400W	Preso tipo Socket type
	2800W	Preso tipo Socket type	G
	2200W	Preso tipo Socket type	I - J - UNIV
	1200W	Preso tipo Socket type	B



PORTE USB DA RICARICA | USB CHARGING PORT

Ingresso Input	100 - 250 Vac 50/60 Hz	
Uscita Output	USB A+A	5V, 2.1A, P.Max. 10,5W (ricarica normale condivisa tra le porte USB-A / standard charging shared between USB-A ports)
	USB A+C	USB C: 5V 3A, 9V 2A, 12V 1.5A max 18W (ricarica rapida / fast charging) USB A: 5V 3A, 9V 2A, 12V 1.5A max 18W (ricarica rapida / fast charging) USB A+ USB C: 5V 3A (1.5+1.5) P.Max. 15W (ricarica normale / standard charging)
	USB C	5V3A, 9V2A, 12V1.5A max 18W (ricarica rapida / fast charging)
Compatibilità Compatibility	Tutti smartphone, tablet e altri dispositivi ricaricabili (fotocamere, auricolari, ecc.) All smartphones, tablets and other USB chargeable devices (cameras, headset etc.)	

CONNETTORI DATI-VOCE | DATA-VOICE CONNECTORS

LAN/Ethernet	RJ45 CAT.6 UTP / RJ45 CAT.6A STP RJ45 CAT.6 UTP / RJ45 CAT.6A STP
USB	USB 3.0 USB 3.0
Video	VGA (15-pin) VGA (15-pin)
Audio	Mini-jack 3.5 mm Mini-jack 3.5 mm
Video - Audio	HDMI Display Port

FINITURE | FINISHES

	Bianco ral 9010 opaco White ral 9010 matt
	Nero ral 9004 opaco Black ral 9004 matt
	Alluminio anodizzato Anodized Aluminium

CERTIFICAZIONI | APPROVALS



NOTE | NOTES

- Personalizzabile per tipo di prese e connettori data
- Disponibili a richiesta altre finiture
- Uso solo in ambienti interni

ATTENZIONE!!!

- Questo apparecchio deve essere collegato a terra
- L'apparecchio deve essere collegato ad una presa principale correttamente installata e provvista di collegamento a terra in accordo alle norme vigenti.
- Se il prodotto viene montato in zone a rischio di contatto con l'acqua, bisogna applicare del silicone o sigillanti similari sul piano dove appoggia la cornice.

- It can be customized according to the type of sockets and data connectors
- Indoor use only
- Other finishes available upon request

WARNING!!!

- This appliance must be earthed
- This appliance must be connected to a main socket correctly installed and provided with ground connection in accordance with current norms.
- If the product is mounted in areas at risk of contact with water, it is necessary to apply silicone or similar sealants on the panel where the frame stands.



RAEE - Rifiuti derivanti da Apparecchiature Elettriche ed Elettroniche. Questi prodotti devono essere riciclati in modo adeguato e non devono essere gettati fra i rifiuti domestici o nei rifiuti municipali indifferenziati.

WEEE - Waste of electric and electronic equipment. These products must be recycled properly and should not be disposed as household waste. Disposal in general household waste is prohibited.

Tutte le dimensioni indicate sono nominali. I disegni e le immagini sono solo a scopo illustrativo. I dettagli del prodotto e le dimensioni sono soggetti a modifiche senza preavviso.

All dimensions quoted are nominal only. Drawings and images are for illustrative purposes only. All product dimensions and specifications are subject to change without notice.

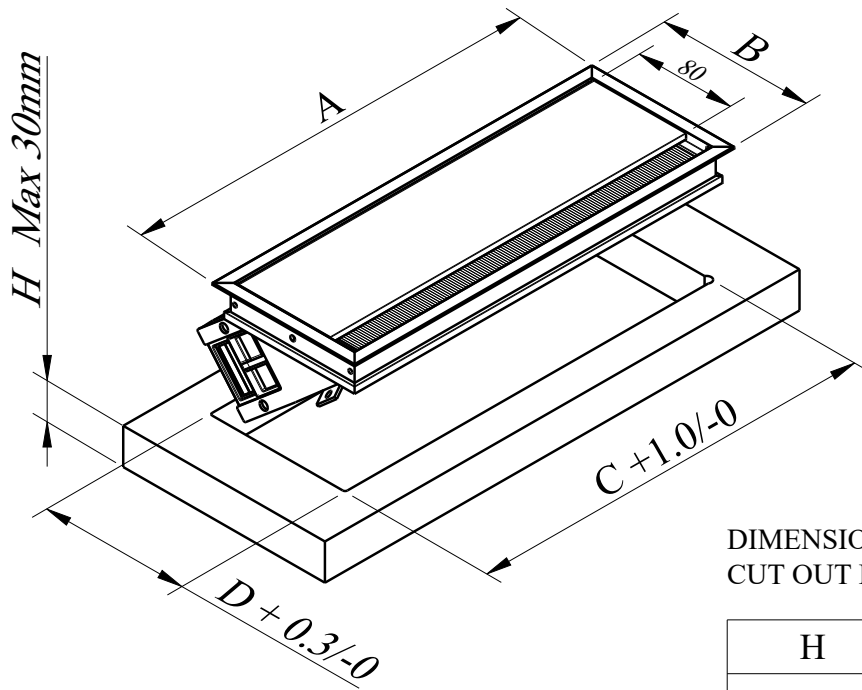

DIMENSIONI TAGLIO DI PIANO (mm)
CUT OUT DIMENSIONS (mm)

H	A	B	C	D
5 ↔ 25	240	120	231	112
5 ↔ 25	320	120	311	112
5 ↔ 25	454	120	445	112
25.1 ↔ 30	240	120	231	114
25.1 ↔ 30	320	120	311	114
25.1 ↔ 30	454	120	445	114

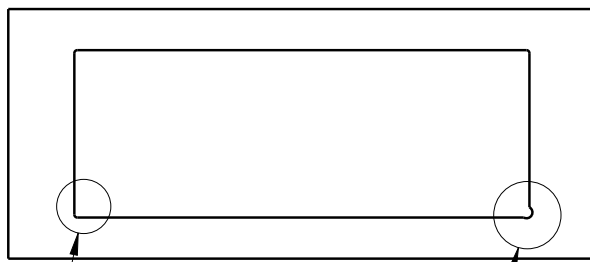

OPZIONE / OPTION A

OPZIONE / OPTION B

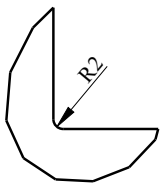

OPZIONE / OPTION A

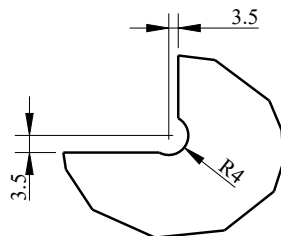

OPZIONE / OPTION B



PIANO / TOP MAX 25 mm
D= 112 mm

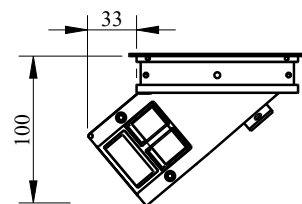
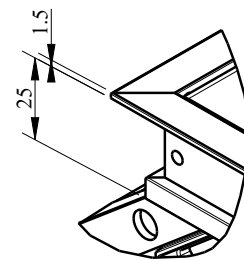

Dimensioni d'ingombro sotto piano (mm)
Overall dimension under the top (mm)

Asa Plastici srl
via Buonarroti, 58/60
20090 | Trezzano S/N (MI) | Italy
Tel/Phone +39 02 4455894 | Fax +39 02 4450107
web@asaplastici.it
asaplastici.com









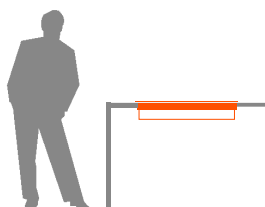
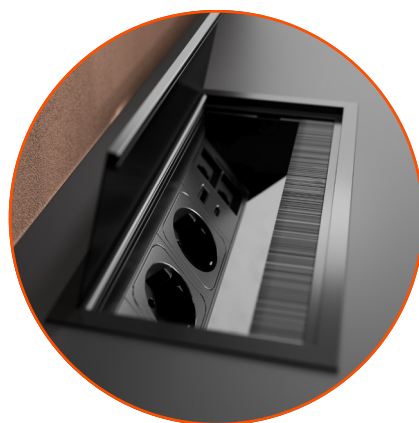
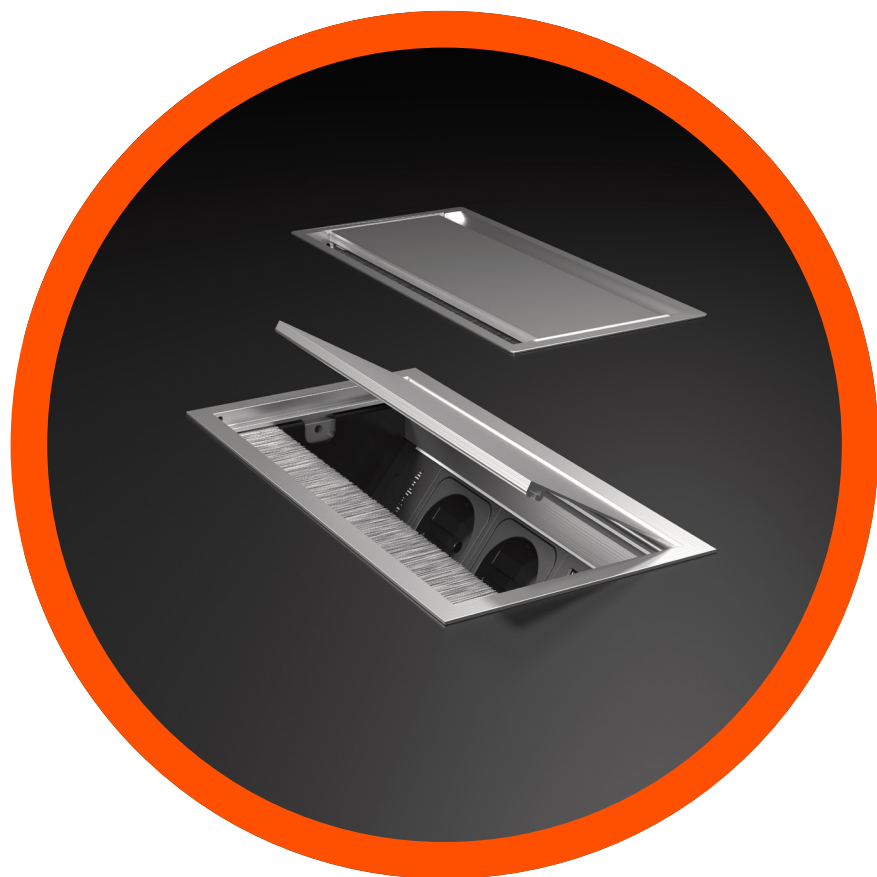





SISTEMI DI ELETTRIFICAZIONE PER PIANO BUILT-IN APPLICATION

VERSAFLAP

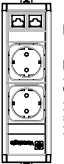
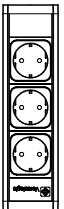
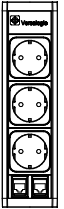
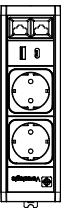









modulo a scomparsa
built-in module



VERSAFLAP						
PRESA SOCKET		  U (UNEL)	  F (SCHUKO)	  E (FRENCH)	  G (UK)	
L240 mm		2 FRUTTI POWER + 2 RJ45 GST IN/OUT 2 POWER SOCKETS + 2 RJ45 GST IN/OUT				
CODICE CODE	alluminio anodizzato anodized aluminum	060.11U.00001	060.11F.00001	060.11E.00001	060.11G.00001	 L = 240 mm
	PREZZO PRICE					
	bianco white	060.11U.00002	060.11F.00002	060.11E.00174	060.11G.00002	
	PREZZO PRICE					
	nero black	060.11U.00049	060.11F.00082	060.11E.00175	060.11G.00048	
		3 FRUTTI POWER 3 POWER SOCKETS				
CODICE CODE	alluminio anodizzato anodized aluminum	060.11U.00003	060.11F.00003	060.11E.00167	060.11G.00003	 L = 240 mm
	PREZZO PRICE					
	bianco white	060.11U.00004	060.11F.00004	060.11E.00168	060.11G.00004	
	PREZZO PRICE					
	nero black	060.11U.00198	060.11F.00083	060.11E.00136	060.11G.00050	
		3 FRUTTI POWER + 2 RJ45 3 POWER SOCKETS + 2 RJ45				
CODICE CODE	alluminio anodizzato anodized aluminum	060.11U.00199	060.11F.00005	060.11E.00005	060.11G.00005	 L = 240 mm
	PREZZO PRICE					
	bianco white	060.11U.00200	060.11F.00006	060.11E.00006	060.11G.00006	
	PREZZO PRICE					
	nero black	060.11U.00201	060.11F.00084	060.11E.00137	060.11G.00051	
		2 FRUTTI POWER + 2 RJ45 + 1 USB 5V (2 PORTE A+C) 2 POWER SOCKETS + 2 RJ45 + 1 USB 5V (2 PORTS A+C)				
CODICE CODE	alluminio anodizzato anodized aluminum	060.11U.00203	060.11F.00091	060.11E.00176	060.11G.00055	 L = 240 mm
	PREZZO PRICE					
	bianco white	060.11U.00204	060.11F.00092	060.11E.00173	060.11G.00056	
	PREZZO PRICE					
	nero black	060.11U.00205	060.11F.00093	060.11E.00177	060.11G.00057	
NOTE NOTES						
DIM. L x H x W 350 x 295 x 426 mm			MOQ 4 PZ / PCS		CODICE DOGANALE CUSTOM CODE 85366990	
CAVI ESCLUSI CABLES NOT INCLUDED		 	TUTTI I CAVI SONO DISPONIBILI NELLA SEZIONE CAVI DEL LISTINO, PAG. 112 ALL CABLES ARE LISTED IN THE PRICE LIST CABLE'S SECTION, PAG. 112			

VERSAFLAP

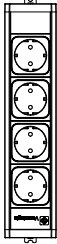

VERSAFLAP

PRESA SOCKET		  U (UNEL)	  F (SCHUKO)	  E (FRENCH)	  G (UK)	
L320 mm		4 FRUTTI POWER 4 POWER SOCKETS				 L = 320 mm
CODICE CODE	alluminio anodizzato anodized aluminum	060.11U.00009	060.11F.00009	060.11E.00009	060.11G.00009	
	PREZZO PRICE					
	bianco white	060.11U.00010	060.11F.00010	060.11E.00010	060.11G.00010	
	PREZZO PRICE					
	nero black	060.11U.00167	060.11F.00081	060.11E.00170	060.11G.00053	
PREZZO PRICE						
		4 FRUTTI POWER + 2 RJ45 4 POWER SOCKETS +2 RJ45				 L = 320 mm
CODICE CODE	alluminio anodizzato anodized aluminum	060.11U.00011	060.11F.00011	060.11E.00011	060.11G.00011	
	PREZZO PRICE					
	bianco white	060.11U.00012	060.11F.00012	060.11E.00012	060.11G.00012	
	PREZZO PRICE					
	nero black	060.11U.00095	060.11F.00087	060.11E.00171	060.11G.00054	
PREZZO PRICE						

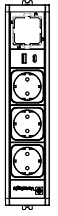
VERSAFLAP PRO

L240 mm		2 FRUTTI POWER + 1 USB 5V (2PORTE A+C) + 1 TUNNEL 2 POWER SOCKETS + 1 USB 5V (2PORTS A+C) + 1 TUNNEL				 L = 240 mm
CODICE CODE	alluminio anodizzato anodized aluminum	061.11U.00050	061.11F.00050	061.11E.00050	061.11G.00050	
	PREZZO PRICE					
	bianco white	061.11U.00044	061.11F.00051	061.11E.00051	061.11G.00051	
	PREZZO PRICE					
	nero black	061.11U.00052	061.11F.00052	061.11E.00052	061.11G.00052	
	PREZZO PRICE					
L320 mm		3 FRUTTI POWER + 1USB 5V (2 PORTE A+C) + 1 TUNNEL 3 POWER SOCKETS + 1USB 5V (2 PORT) A+C) + 1 TUNNEL				 L = 320 mm
CODICE CODE	alluminio anodizzato anodized aluminum	061.11U.00030	061.11F.00025	061.11E.00029	061.11G.00023	
	PREZZO PRICE					
	bianco white	061.11U.00031	061.11F.00026	061.11E.00030	061.11G.00024	
	PREZZO PRICE					
	nero black	061.11U.00032	061.11F.00027	061.11E.00031	061.11G.00025	
	PREZZO PRICE					

NOTE | NOTES

DIM: L x H x W 350 x 295 x 426 mm		MOQ 4 PZ / PCS	CODICE DOGANALE CUSTOM CODE 85366990
CAVI ESCLUSI CABLES NOT INCLUDED	 	TUTTI I CAVI SONO DISPONIBILI NELLA SEZIONE CAVI DEL LISTINO, PAG. 112 ALL CABLES ARE LISTED IN THE PRICE LIST CABLE'S SECTION, PAG. 112	