

# VERSAHIT dual

Modulo cablato a scomparsa con sportelli scorrevoli |  
Powerdock with independent sliding covers

SCHEDA TECNICA | DATA SHEET

ED.18\_24.01.2024

# VERSAHIT dual

Modulo cablato a scomparsa con sportelli scorrevoli |  
Powerdock with independent sliding covers

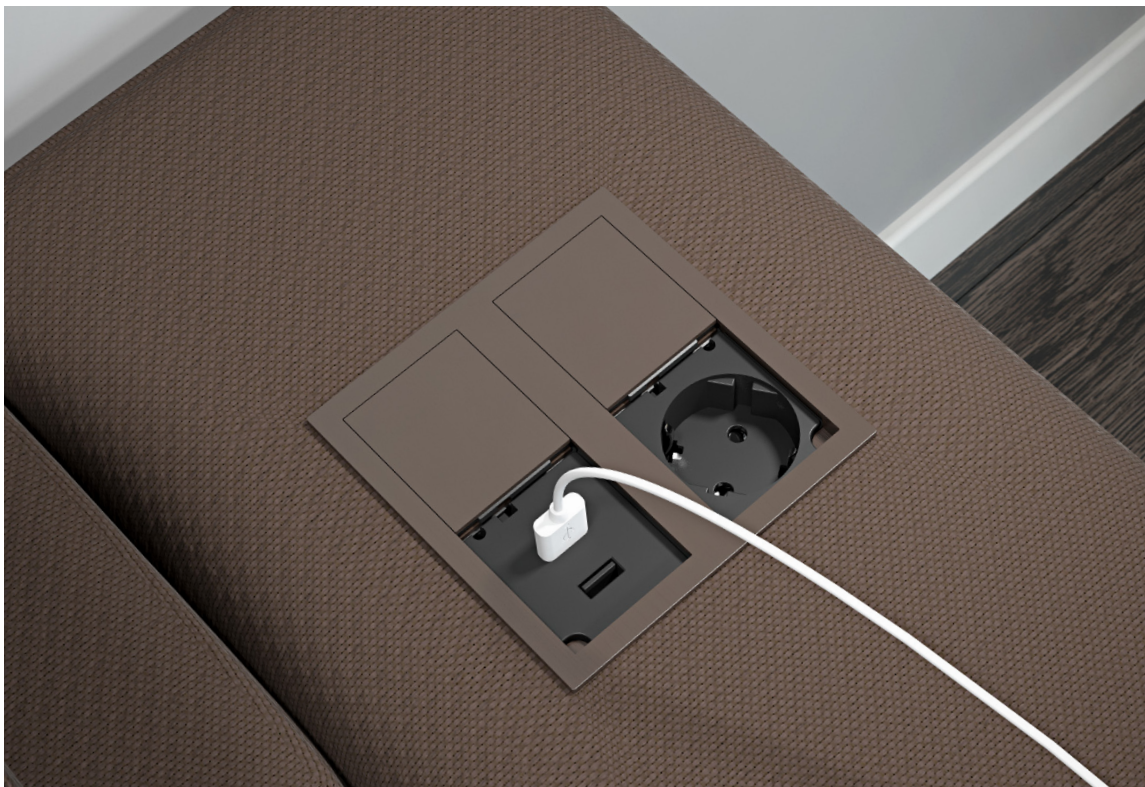

## DATI COMMERCIALI | COMMERCIAL DATA

|                                 |        |  |
|---------------------------------|--------|--|
| Codice prodotto<br>Product code | 060.15 | Codice famiglia di prodotto - Valido per tutte le configurazioni<br>Family product code - Valid for all configurations |
|---------------------------------|--------|--|

## DATI TECNICI | TECHNICAL DATA





### GENERALE | GENERAL

|   |                       |   |
|---|-----------------------|---|
| Tensione nominale<br>Rated voltage            | 110 - 250 V ac, 50 Hz |   |
| Corrente nominale<br>Rated current            | 10 - 16A              |   |
| Grado di protezione<br>Degree of protection   | IP54                  | A coperchi chiusi<br>With closed covers |
| Ambiente di utilizzo<br>Operating environment | Interno<br>Indoor     |   |

## MATERIALI | MATERIALS

|   |  |
|---|--|
| Corpo<br>Body                           | Tecnopolimero autoestinguente<br>Flame retardant polymer |
| Cornice e sportelli<br>Frame and covers | Zama<br>Zamak  |
| Prese elettriche<br>Electric Sockets    | Tecnopolimero autoestinguente<br>Flame retardant polymer |









## PRESE ELETTRICHE | ELECTRIC SOCKETS

|  |   |   |   |   |
|--|---|---|---|---|
| Tipo<br>Type                                 | B - E - F - J - H, 2P+T, con otturatori (protezione bimbi)<br>B - E - F - J - H, 2P+T, with shutters (child protection) |   |   |   |
|  |  B                                     |  E |  F |  J |
| Vtaggio<br>Rated voltage                     | 220 - 250 V ac,<br>50 Hz  | Presse tipo I Socket type   | E - F - H - J   |   |
|  | 110 - 125 V ac,<br>60 Hz  | Presse tipo I Socket type   | B   |   |
| Corrente<br>Rated current                    | 16 A  | Presse tipo I Socket type   | E - F - H   |   |
|  | 12 A  | Presse tipo I Socket type   | B   |   |
|  | 10 A  | Presse tipo I Socket type   | J   |   |
|  |   |   |   |   |
| Carico massimo complessivo<br>Max.load power | 3400W   | Presse tipo I Socket type   | E - F - H   |   |
|  | 2200W   | Presse tipo I Socket type   | J   |   |
|  | 1200W   | Presse tipo I Socket type   | B   |   |

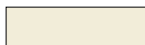
## PORTE USB DA RICARICA | USB CHARGING PORT

|                                |   |  |  |
|--------------------------------|---|--|--|
| Ingresso<br>Input              | 100 - 240 V ac, 0.5A  |  |  |
| Uscita<br>Output               | USB A+C   | USB C: 5V 2.4A, 12 W (condiviso tra USB A e USB C / shared between USB A and USB C)<br>(ricarica standard / standard charging) |  |
| Compatibilità<br>Compatibility | Tutti smartphone, tablet e altri dispositivi ricaricabili (fotocamere, auricolari, ecc.)<br>All smartphones, tablets and other USB chargeable devices (cameras, headset etc.) |  |  |

## FINITURE | FINISHES

|   |                                       |  |                          |
|---|---------------------------------------|--|--------------------------|
| Cornice e sportelli   Frame and covers  |                                       |  |                          |
|  | Acciaio spazzolato<br>Stainless steel |  | Bronzo<br>Bronze         |
|  | Champagne<br>Champagne                |  | Peltro<br>Pewter         |
|  | Oro<br>Gold                           |  | Nero opaco<br>Matt black |
|  | Bianco opaco<br>Matt white            |  | Rame<br>Copper           |



## NOTE | NOTES

- Disponibili a richiesta altre finiture.
- Uso solo in ambienti interni.

Significato per la protezione IP 54: a coperchi chiusi, la penetrazione di polveri e liquidi non danneggerà l'apparecchiatura.

Prima cifra caratteristica indica il grado di protezione contro l'accesso a parti pericolose e contro i corpi solidi estranei.

5\* Protetto contro la polvere» protezione totale contro la penetrazione di corpi solidi.

Seconda cifra caratteristica indica il grado di protezione contro l'acqua. 4\* Protezione contro la penetrazione di acqua spruzzata sull'involucro da tutte le direzioni.

\* Il grado di protezione del prodotto è garantito solo a coperchi chiusi.

- Attenzione: Il prodotto è stato studiato per drenare l'acqua che accidentalmente può essere rovesciata sopra (a coperchi chiusi), per questo motivo assicurarsi che il fondo dell'alloggiamento del prodotto sia sempre libero affinché possa fuoriuscire l'acqua presente all'interno.

- Prestare particolare cura nella fase di installazione in quanto il prodotto non è previsto con un vaschetta raccogli acqua quindi non deve essere posizionato nelle zone dove l'acqua drenata sottostante può provocare dei danni.

- Se il prodotto viene montato in zone a rischio di contatto con l'acqua, bisogna applicare del silicone o sigillanti similari sul piano dove appoggia la cornice.

- L'apparecchio deve essere collegato ad una presa principale correttamente installata e provvista di collegamento a terra in accordo alle norme vigenti.

- Other finishes available upon request.
- Indoor use only.

Meaning for the protection IP54: With closed covers, the access of dust and liquids will not damage the device.

First characteristic numeral indicates the degree of protection against access to hazardous parts and against solid foreign objects.

5\* Protected against dust» Total protection against access of solid foreign objects.

Second characteristic numeral indicates the degree of protection against water.

4\* Protection against ingress of water splashed on the housing from all directions.

\* The IP protection degree is guaranteed only with closed lids

- Warning: The product was designed to drain water that may be accidentally spilled over (when the lids are closed), for this reason make sure that the bottom side of the housing of the product is always free so that it can drain the water inside.

- Pay particular care during installation because the product is not provided with a water collecting tray so should not be placed in areas where the drained water below can cause damages.

- If the product is mounted in areas at risk of contact with water, it is necessary to apply silicone or similar sealants on the panel where the frame stands.

- This appliance must be connected to a main socket correctly installed and provided with ground connection in accordance with current norms.



RAEE - Rifiuti derivanti da Apparecchiature Elettriche ed Elettroniche. Questi prodotti devono essere riciclati in modo adeguato e non devono essere gettati fra i rifiuti domestici o nei rifiuti municipali indifferenziati.

WEEE - Waste of electric and electronic equipment. These products must be recycled properly and should not be disposed as household waste. Disposal in general household waste is prohibited.

Tutte le dimensioni indicate sono nominali. I disegni e le immagini sono solo a scopo illustrativo. I dettagli del prodotto e le dimensioni sono soggetti a modifiche senza preavviso.

All dimensions quoted are nominal only. Drawings and images are for illustrative purposes only. All product dimensions and specifications are subject to change without notice.

DIMENSIONI (mm) | DIMENSIONS (mm)

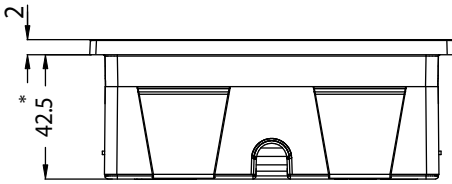

\*presa svizzera 50 mm  
\*swiss socket

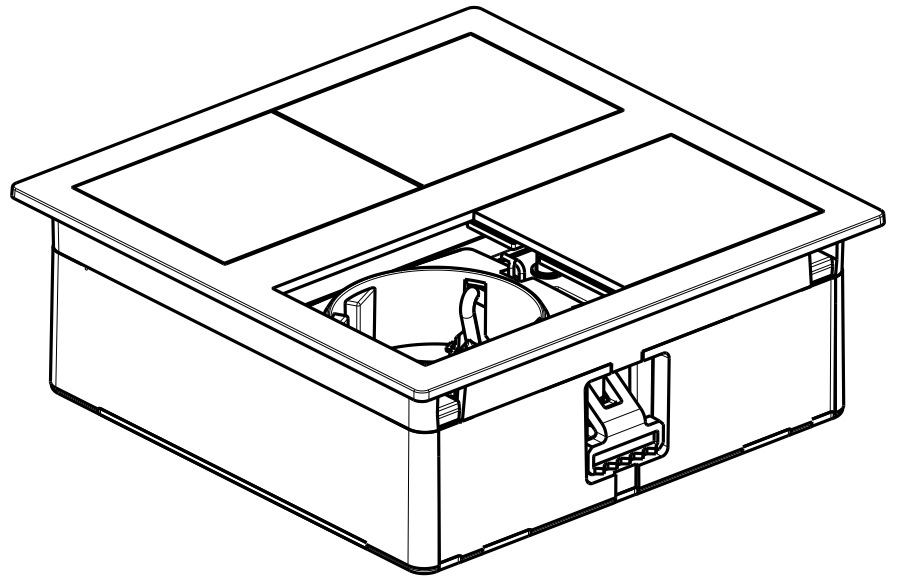
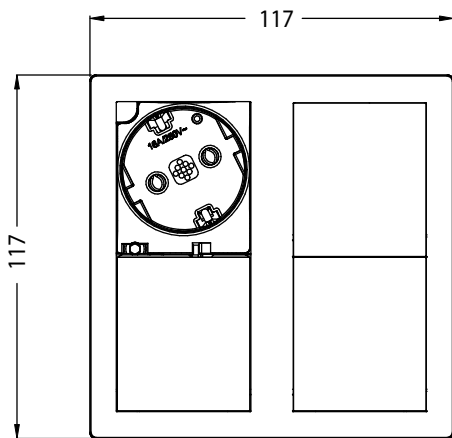



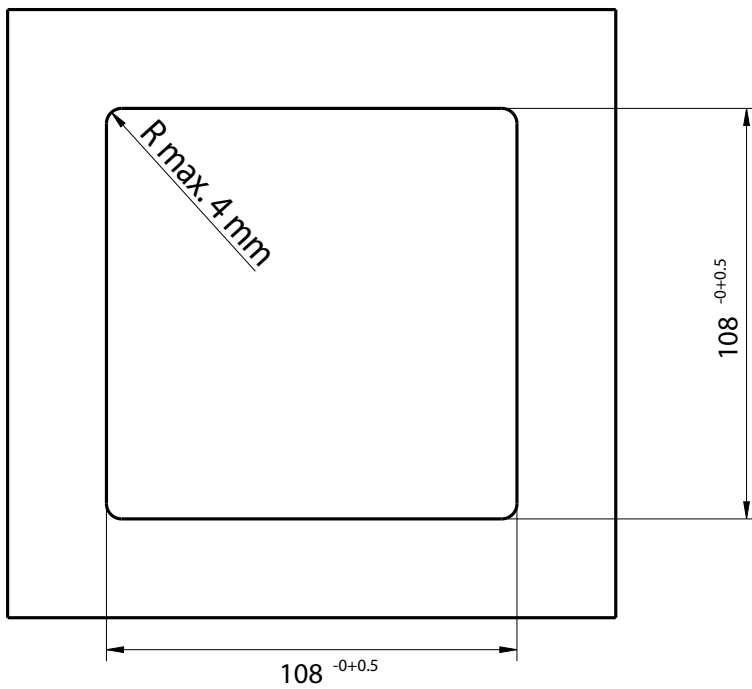







PIANO DI TAGLIO | CUT OUT DIMENSION

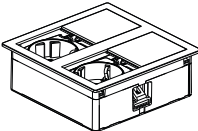
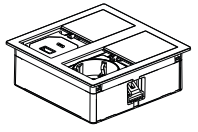

Asa Plastici srl  
via Buonarroti, 58/60  
20090 | Trezzano S/N (MI) | Italy  
Tel/Phone +39 02 4455894 | Fax +39 02 4450107  
web@asaplastici.it  
asaplastici.com



| VERSAHIT DUAL   |   | VERSAHIT DUAL COMBI*  |  |
|---|---|---|--|
| PRESA   SOCKET  |  <br>F (SCHUKO) |  <br>E (FRENCH) |  <br>G (UK) * |
| Cavo 2000 mm con spina separata<br>2000 mm cable / separated plug | 2 FRUTTI POWER<br>2 POWER SOCKETS   |   |  |
| acciaio spazzolato<br>stainless steel                             | 060.15F.00001   | 060.15E.00001   |   |
| PREZZO   PRICE  |   |   |  |
| champagne<br>champagne  | 060.15F.00034   | 060.15E.00020   |  |
| PREZZO   PRICE  |   |   |  |
| oro verniciato<br>painted gold                                    | 060.15F.00003   | 060.15E.00003   |  |
| PREZZO   PRICE  |   |   |  |
| bronzo<br>bronze  | 060.15F.00004   | 060.15E.00004   |  |
| PREZZO   PRICE  |   |   |  |
| peltro<br>pewter  | 060.15F.00005   | 060.15E.00005   |  |
| PREZZO   PRICE  |   |   |  |
| rame<br>copper  | 060.15F.00046   | 060.15E.00046   |  |
| PREZZO   PRICE  |   |   |  |
| bianco opaco<br>matt white  | 060.15F.00008   | 060.15E.00008   |  |
| PREZZO   PRICE  |   |   |  |
| nero opaco<br>matt black  | 060.15F.00007   | 060.15E.00007   |  |
| PREZZO   PRICE  |   |   |  |
| Cavo 2000 mm con spina separata<br>2000 mm cable / separated plug | 1 FRUTTO POWER + 1 USB 5V (2 PORTE A+C)<br>1 POWER SOCKET + 1 USB 5V (2PORTS A+C)   |   |  |
| acciaio spazzolato<br>stainless steel                             | 060.15F.00038   | 060.15E.00022   |   |
| PREZZO   PRICE  |   |   |  |
| champagne<br>champagne  | 060.15F.00039   | 060.15E.00023   |  |
| PREZZO   PRICE  |   |   |  |
| oro verniciato<br>painted gold                                    | 060.15F.00040   | 060.15E.00024   |  |
| PREZZO   PRICE  |   |   |  |
| bronzo<br>bronze  | 060.15F.00041   | 060.15E.00025   |  |
| PREZZO   PRICE  |   |   |  |
| peltro<br>pewter  | 060.15F.00042   | 060.15E.00026   |  |
| PREZZO   PRICE  |   |   |  |
| rame<br>copper  | 060.15F.00048   | 060.15E.00048   |  |
| PREZZO   PRICE  |   |   |  |
| bianco opaco<br>matt white  | 060.15F.00044   | 060.15E.00028   |  |
| PREZZO   PRICE  |   |   |  |
| nero opaco<br>matt black  | 060.15F.00045   | 060.15E.00029   |  |
| PREZZO   PRICE  |   |   |  |
| <b>NOTE   NOTES</b>   |   |   |  |
| DIM. L x H x W<br>390 X 280 X 320 mm                              |    | PESO<br>WEIGHT<br>7,5 kg  | PEZZI PER SCATOLA<br>PCS PER BOX<br>8  |
| CAVI INCLUSI   CABLES INCLUDED<br>2 metri / meters                |             | CAVO ALIMENTAZIONE CON SPINA SEPARATA<br>POWER CABLE FREE END PLUS SEPARATE PLUG  |  |
|   |   |   | MOQ<br>8 PZ / PCS  |
|   |   |   | CODICE DOGANALE<br>CUSTOM CODE<br>85366990   |
|   |   |   | *PIANO DI TAGLIO<br>DIFFERENTE<br>*DIFFERENT CUT OUT<br>DIMENSION  |

VERSAHIT