

VERSAHIT mono

Modulo cablato a scomparsa con sportello scorrevole |
Powerdock with independent sliding covers

SCHEDA TECNICA | DATA SHEET

ED.11_24.01.2024

VERSAHIT mono

Modulo cablato a scomparsa con sportello scorrevole |
Powerdock with independent sliding covers



DATI COMMERCIALI | COMMERCIAL DATA

Codice prodotto Product code	060.25	Codice famiglia di prodotto - Valido per tutte le configurazioni Family product code - Valid for all configurations
---------------------------------	--------	--

DATI TECNICI | TECHNICAL DATA



GENERALE | GENERAL

Tensione nominale Rated voltage	110 - 250 V ac, 50 Hz	
Corrente nominale Rated current	10 - 16A	
Grado di protezione Degree of protection	IP54	A coperchi chiusi With closed covers
Ambiente di utilizzo Operating environment	Interno Indoor	

MATERIALI | MATERIALS

Corpo Body	Tecnopolimero autoestinguente Flame retardant polymer
Cornice e sportelli Frame and covers	Zama Zamak
Prese elettriche Electric Sockets	Tecnopolimero autoestinguente Flame retardant polymer









PRESE ELETTRICHE | ELECTRIC SOCKETS

Tipo Type	E - F - G, 2P+T, con otturatori (protezione bimbi) E - F - G, 2P+T, with shutters (child protection)		
	 E	 F	 G
Voltaggio Rated voltage	220 - 250 V ac, 50 Hz	Preso tipo I Socket type	E - F - G
Corrente Rated current	16 A	Preso tipo I Socket type	E - F
	13 A	Preso tipo I Socket type	G
Carico massimo complessivo Max.load power	3400W	Preso tipo I Socket type	E - F
	2800W	Preso tipo I Socket type	G

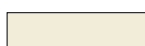
PORTE USB DA RICARICA | USB CHARGING PORT

Ingresso Input	100 - 250 Vac 50/60 Hz		
Uscita Output	USB A+C	5V, 2.4A, PMax. 12W (ricarica normale condivisa tra le porte USB-A e USB-C / standard charging shared between USB-A and USB-Cports)	
Compatibilità Compatibility	Tutti smartphone, tablet e altri dispositivi ricaricabili (fotocamere, auricolari, ecc.) All smartphones, tablets and other USB chargeable devices (cameras, headset etc.)		

FINITURE | FINISHES

Cornice e sportelli Frame and covers			
	Acciaio spazzolato Stainless steel		Bronzo Bronze
	Champagne Champagne		Peltro Pewter
	Oro Gold		Nero opaco Matt black
	Bianco opaco Matt white		Rame Copper



NOTE | NOTES

- Disponibili a richiesta altre finiture.
- Uso solo in ambienti interni.

Significato per la protezione IP 54: a coperchi chiusi, la penetrazione di polveri e liquidi non danneggerà l'apparecchiatura.

Prima cifra caratteristica indica il grado di protezione contro l'accesso a parti pericolose e contro i corpi solidi estranei.

5* Protetto contro la polvere» protezione totale contro la penetrazione di corpi solidi.

Seconda cifra caratteristica indica il grado di protezione contro l'acqua. 4* Protezione contro la penetrazione di acqua spruzzata sull'involucro da tutte le direzioni.

* Il grado di protezione del prodotto è garantito solo a coperchi chiusi.

- Attenzione: Il prodotto è stato studiato per drenare l'acqua che accidentalmente può essere rovesciata sopra (a coperchi chiusi), per questo motivo assicurarsi che il fondo dell'alloggiamento del prodotto sia sempre libero affinché possa fuoriuscire l'acqua presente all'interno.

- Prestare particolare cura nella fase di installazione in quanto il prodotto non è previsto con un vaschetta raccogli acqua quindi non deve essere posizionato nelle zone dove l'acqua drenata sottostante può provocare dei danni.

- Se il prodotto viene montato in zone a rischio di contatto con l'acqua, bisogna applicare del silicone o sigillanti similari sul piano dove appoggia la cornice.

- L'apparecchio deve essere collegato ad una presa principale correttamente installata e provvista di collegamento a terra in accordo alle norme vigenti.

- Other finishes available upon request.
- Indoor use only.

Meaning for the protection IP54: With closed covers, the access of dust and liquids will not damage the device.

First characteristic numeral indicates the degree of protection against access to hazardous parts and against solid foreign objects.

5* Protected against dust» Total protection against access of solid foreign objects.

Second characteristic numeral indicates the degree of protection against water.

4* Protection against ingress of water splashed on the housing from all directions.

* The IP protection degree is guaranteed only with closed lids

- Warning: The product was designed to drain water that may be accidentally spilled over (when the lids are closed), for this reason make sure that the bottom side of the housing of the product is always free so that it can drain the water inside.

- Pay particular care during installation because the product is not provided with a water collecting tray so should not be placed in areas where the drained water below can cause damages.

- If the product is mounted in areas at risk of contact with water, it is necessary to apply silicone or similar sealants on the panel where the frame stands.

- This appliance must be connected to a main socket correctly installed and provided with ground connection in accordance with current norms.



RAEE - Rifiuti derivanti da Apparecchiature Elettriche ed Elettroniche. Questi prodotti devono essere riciclati in modo adeguato e non devono essere gettati fra i rifiuti domestici o nei rifiuti municipali indifferenziati.

WEEE - Waste of electric and electronic equipment. These products must be recycled properly and should not be disposed as household waste. Disposal in general household waste is prohibited.





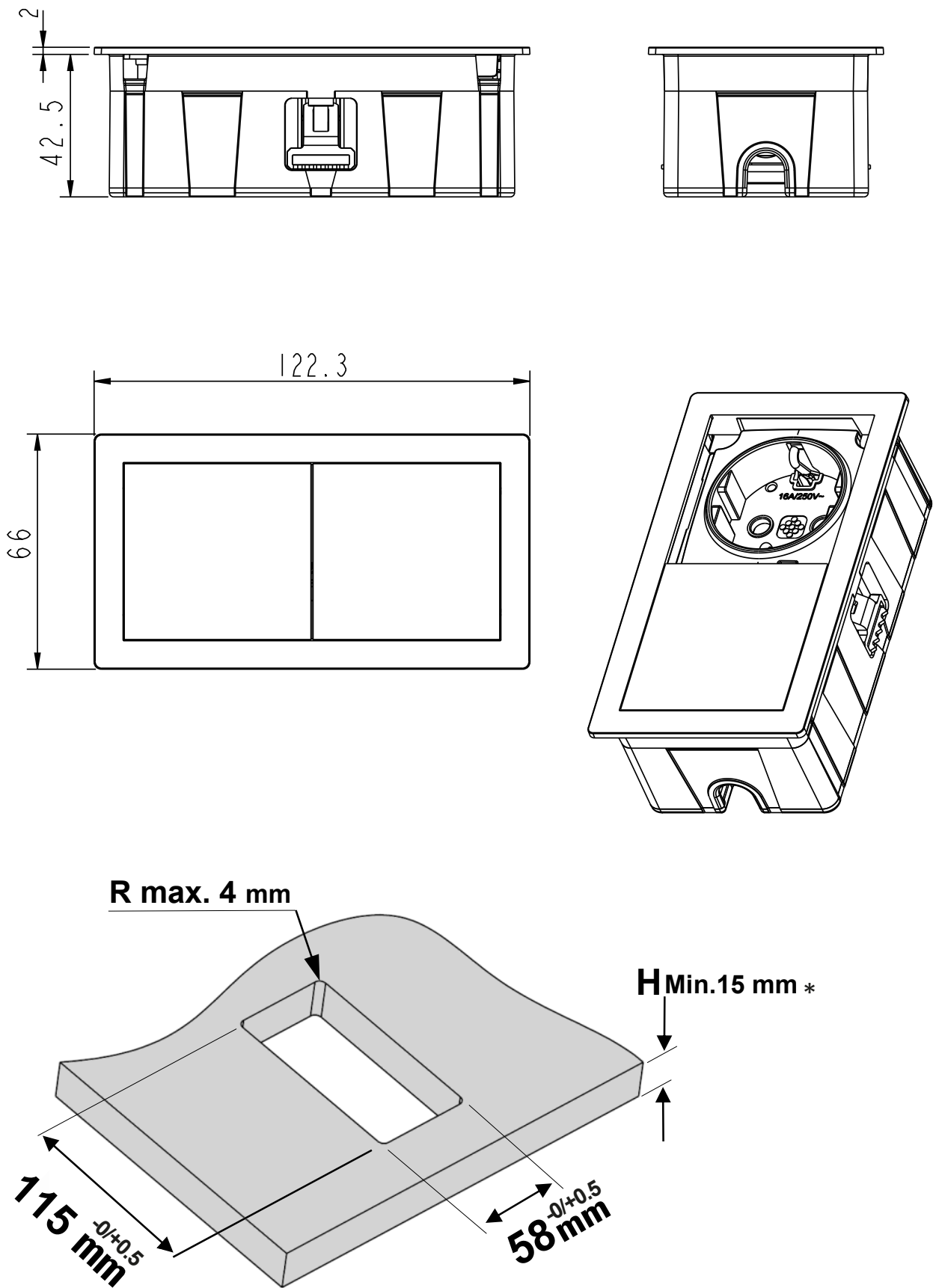







Tutte le dimensioni indicate sono nominali. I disegni e le immagini sono solo a scopo illustrativo. I dettagli del prodotto e le dimensioni sono soggetti a modifiche senza preavviso.

All dimensions quoted are nominal only. Drawings and images are for illustrative purposes only. All product dimensions and specifications are subject to change without notice.

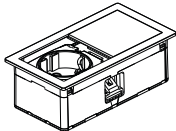
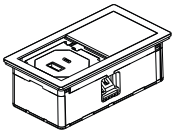

Asa Plastici srl
via Buonarroti, 58/60
20090 | Trezzano S/N (MI) | Italy
Tel/Phone +39 02 4455894 | Fax +39 02 4450107
web@asaplastici.it
asaplastici.com



VERSAHIT MONO					
	  F (SCHUKO)	  E (FRENCH)	  G (UK)	 + 	
Cavo 2000 mm con spina separata 2000 mm cable / separated plug	1 FRUTTO POWER 1 POWER SOCKET			1 USB 5V (2 PORTE A+C) 1 USB 5V (2 PORTS A+C)	
acciaio spazzolato stainless steel	060.25F.00001	060.25E.00001	060.25G.00001	060.25Y.00014	 
PREZZO PRICE					
champagne champagne	060.25F.00014	060.25E.00014	060.25G.00010	060.25Y.00015	
PREZZO PRICE					
oro verniciato painted gold	060.25F.00003	060.25E.00003	060.25G.00003	060.25Y.00016	
PREZZO PRICE					
bronzo bronze	060.25F.00004	060.25E.00004	060.25G.00004	060.25Y.00017	
PREZZO PRICE					
peltro pewter	060.25F.00005	060.25E.00005	060.25G.00005	060.25Y.00018	
PREZZO PRICE					
rame copper	060.25F.00047	060.25E.00047	060.25G.00047	060.25Y.00029	
PREZZO PRICE					
bianco opaco matt white	060.25F.00007	060.25E.00007	060.25G.00007	060.25Y.00020	
PREZZO PRICE					
nero opaco matt black	060.25F.00008	060.25E.00008	060.25G.00008	060.25Y.00021	
PREZZO PRICE					
NOTE NOTES					
DIM. L x H x W 390 X 280 X 320 mm		PESO WEIGHT 7,5 kg	PEZZI PER SCATOLA PCS PER BOX 8	MOQ 8 PZ / PCS	CODICE DOGANALE CUSTOM CODE 85366990
CAVI INCLUSI CABLES INCLUDED 2 metri / meters	 	CAVO ALIMENTAZIONE CON SPINA SEPARATA POWER CABLE FREE END PLUS SEPARATE PLUG			

VERSAHIT