

VERSALUX

torretta estraibile delux I
delux concealed power dock

SCHEDA TECNICA | DATA SHEET

ED.06_05.09.2023

VERSALUX

torretta estraibile delux I
delux concealed power dock

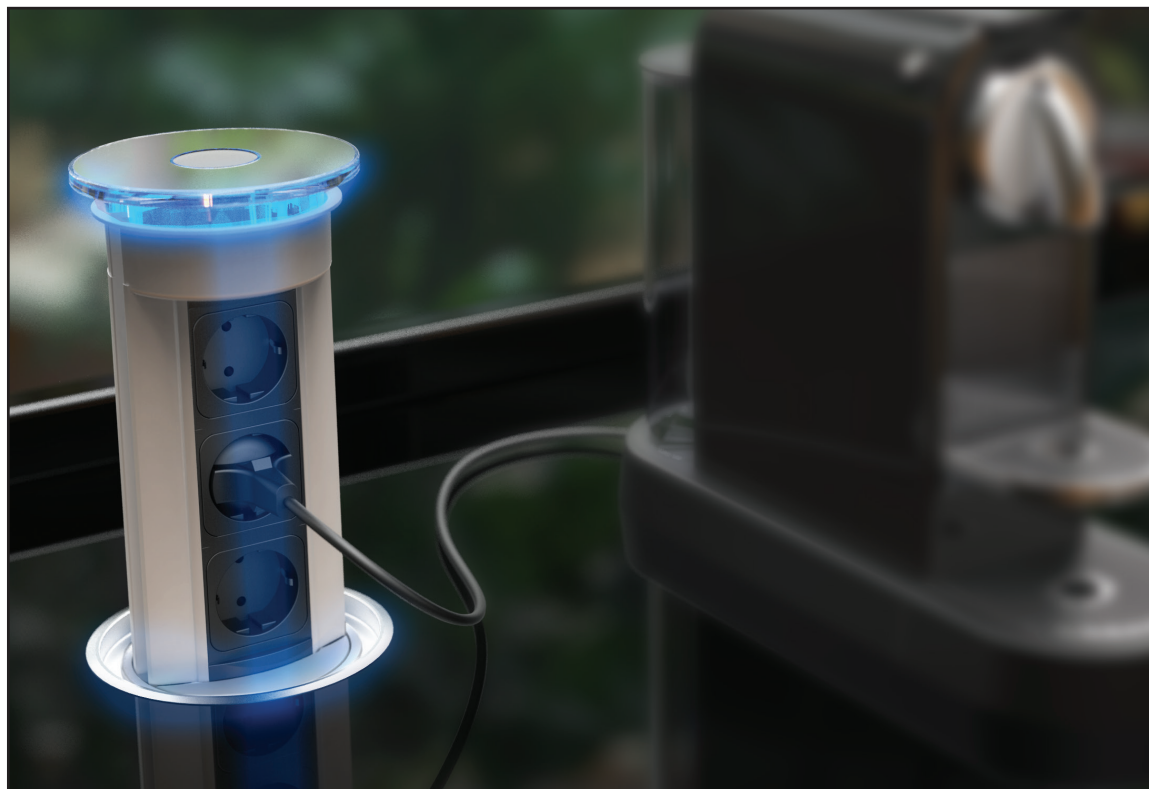

DATI COMMERCIALI | COMMERCIAL DATA

Codice prodotto Product code	060.24	Codice famiglia di prodotto - Valido per tutte le configurazioni Family product code - Valid for all configurations
---------------------------------	---------------------	--

DATI TECNICI | TECHNICAL DATA

GENERALE | GENERAL

Tensione nominale Rated voltage	110 - 250 V ac, 50 Hz
------------------------------------	-----------------------

Corrente nominale Rated current	10 - 16A
------------------------------------	----------

Grado di protezione Degree of protection	IP20
---	------

Ambiente di utilizzo Operating environment	Interno Indoor
---	-------------------

MATERIALI | MATERIALS

Profil Profile	Alluminio Aluminium
Coperchio ed elementi di fissaggio Cover and fixing elements	Tecnopolimero autoestinguente Flame retardant polymer
Prese elettriche Electric Sockets	Tecnopolimero autoestinguente Flame retardant polymer

PRESE ELETTRICHE | ELECTRIC SOCKETS

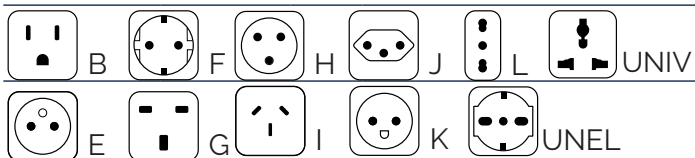
	B - E - F - G - H - I - J - K - L - Univ, Unel, 2P+T, con otturatori (protezione bimbi) B - E - F - G - H - I - J - K - L - Univ Unel, 2P+T, with shutters (child protection)		
Tipo Type			
	220 - 250 V ac, 50 Hz	Preso tipo Socket type	E - F - G - H - I - J - K - L - UNEL - UNIV
Voltaggio Rated voltage	110 - 125 V ac, 60 Hz	Preso tipo Socket type	B - UNIV
	16 A	Preso tipo Socket type	E - F - H - K - L - UNEL
	15 A	Preso tipo Socket type	B
	13 A	Preso tipo Socket type	G
Corrente Rated current	10 A	Preso tipo Socket type	I - J - UNIV
	3400W	Preso tipo Socket type	E - F - H - K - L - UNEL
	2800W	Preso tipo Socket type	G
	2200W	Preso tipo Socket type	I - J - UNIV
Carico massimo complessivo Max.load power	1200W	Preso tipo Socket type	B



PORTE USB DA RICARICA | USB CHARGING PORT

Ingresso Input	100 - 250 Vac 50/60 Hz	
Uscita Output	USB A+A	5V, 2.1A, P.Max. 10.5W (ricarica normale condivisa tra le porte USB-A / standard charging shared between USB-A ports)
	USB A+C	USB C: 5V 3A, 9V 2A, 12V 1.5A max 18W (ricarica rapida / fast charging) USB A: 5V 3A, 9V 2A, 12V 1.5A max 18W (ricarica rapida / fast charging) USB A+ USB C: 5V 3A (1.5+1.5) P.Max. 15W (ricarica normale / standard charging)
Compatibilità Compatibility	Tutti smartphone, tablet e altri dispositivi ricaricabili (fotocamere, auricolari, ecc.) All smartphones, tablets and other USB chargeable devices (cameras, headset etc.)	

CONNETTORI DATI-VOCE | DATA-VOICE CONNECTORS

LAN/Ethernet	RJ45 CAT.6 UTP / RJ45 CAT.6A STP RJ45 CAT.6 UTP / RJ45 CAT.6A STP
USB	USB 2.0 USB 2.0
Video	VGA (15-pin) VGA (15-pin)
Audio	Mini-jack 3.5 mm Mini-jack 3.5 mm
Video - Audio	HDMI Display Port

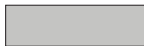
FINITURE | FINISHES

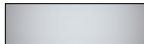
Tappo Stopper	Profilo Profile
 Acciaio Lucido Silver	 Alluminio anodizzato Anodized aluminium
 Acciaio spazzolato Brushed stainless steel	 Cromo Chrome

CERTIFICAZIONI | APPROVALS

NOTE | NOTES



- Personalizzabile per tipo di prese e connettori data
- Disponibili a richiesta altre finiture
- Uso solo in ambienti interni

ATTENZIONE!!!

- Questo apparecchio deve essere collegato a terra
- L'apparecchio deve essere collegato ad una presa principale correttamente installata e provvista di collegamento a terra in accordo alle norme vigenti.
- Se il prodotto viene montato in zone a rischio di contatto con l'acqua, bisogna applicare del silicone o sigillanti simili sul piano dove appoggia la cornice.

- It can be customized according to the type of sockets and data connectors
- Indoor use only
- Other finishes available upon request

WARNING!!!

- This appliance must be earthed
- This appliance must be connected to a main socket correctly installed and provided with ground connection in accordance with current norms.
- If the product is mounted in areas at risk of contact with water, it is necessary to apply silicone or similar sealants on the panel where the frame stands.



RAEE - Rifiuti derivanti da Apparecchiature Elettriche ed Elettroniche. Questi prodotti devono essere riciclati in modo adeguato e non devono essere gettati fra i rifiuti domestici o nei rifiuti municipali indifferenziati.

WEEE - Waste of electric and electronic equipment. These products must be recycled properly and should not be disposed as household waste. Disposal in general household waste is prohibited.

Tutte le dimensioni indicate sono nominali. I disegni e le immagini sono solo a scopo illustrativo. I dettagli del prodotto e le dimensioni sono soggetti a modifiche senza preavviso.

All dimensions quoted are nominal only. Drawings and images are for illustrative purposes only. All product dimensions and specifications are subject to change without notice.

DIMENSIONI (mm) | DIMENSIONS (mm)

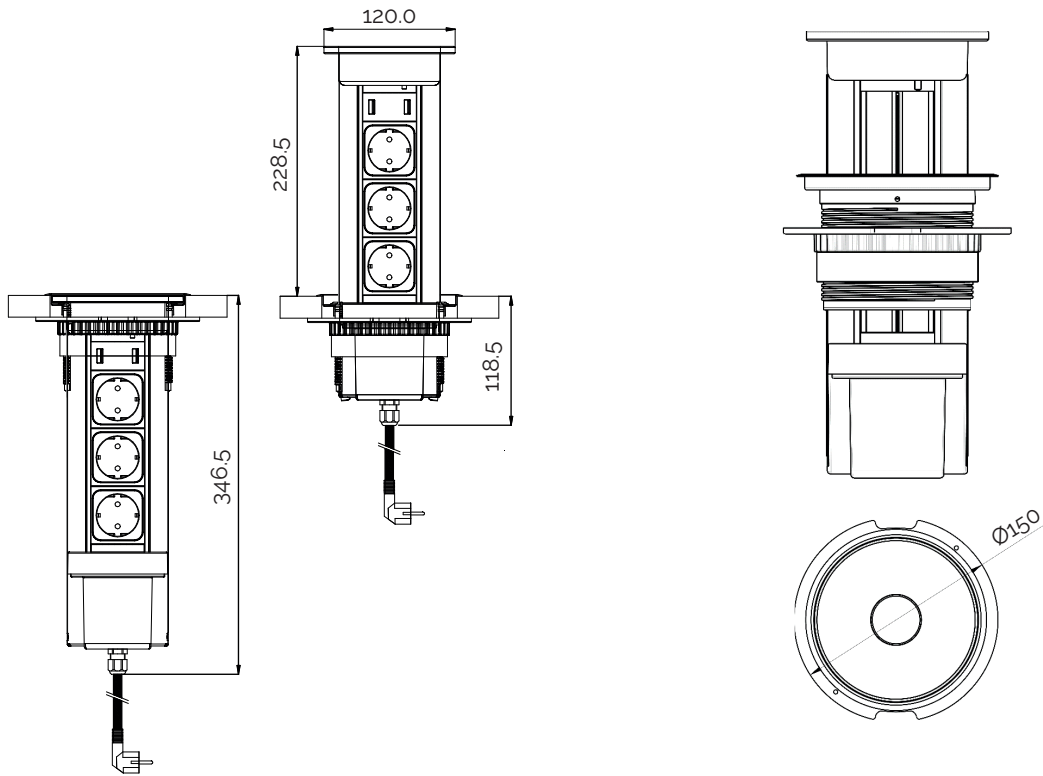

CON E SENZA FLANGIA FILO PIANO | WITH AND WITHOUT FLUSH FIT ADAPTOR

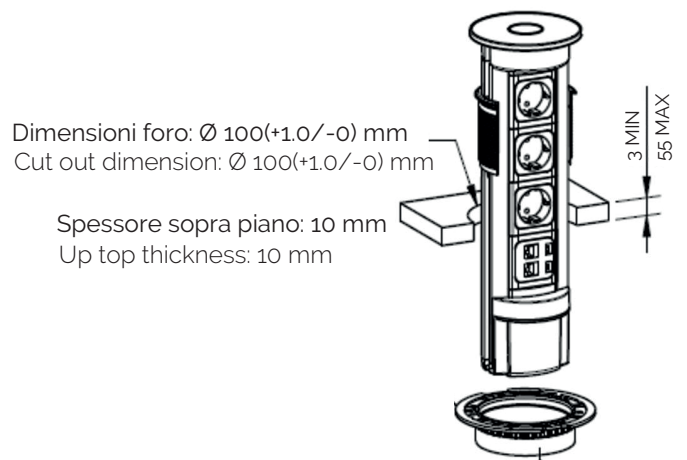
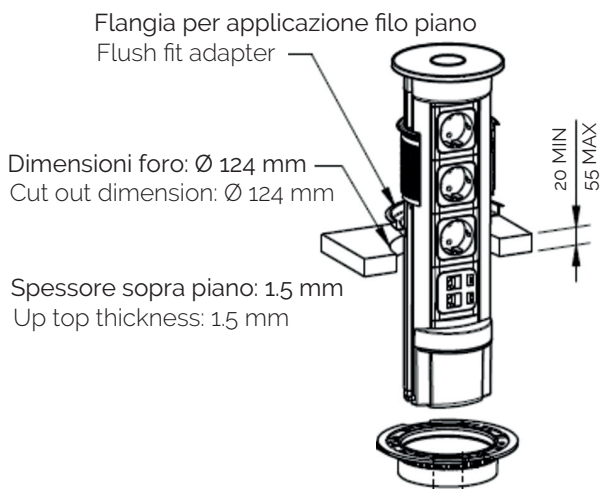

Asa Plastici srl
via Buonarroti, 58/60
20090 | Trezzano S/N (MI) | Italy
Tel/Phone +39 02 4455894 | Fax +39 02 4450107
web@asaplastici.it
asaplastici.com















TORRETTE A SCOMPARSA CONCEALED POWERDOCK

VERSALUX

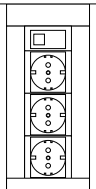
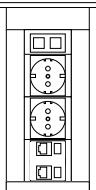
torretta estraibile Delux
Deluxe concealed powerdock



VERSALUX						
PRESA SOCKET		 	 	 	 	
		U (UNEL)	F (SCHUKO)	E (FRENCH)	G (UK)	
Cavo 2000 mm 2000 mm cable		3 FRUTTI POWER + 1 USB 5V (2 PORTE A+A) + 1 LED BLU 3 POWER SOCKETS + 1 USB 5V (2 PORT A+A) + 1 LED blue				
CODICE CODE	profilo alluminio, tappo acciaio inox aluminum profile, inox cover	060.13U.00001	060.13F.00001	060.13E.00001	060.13G.00001	 L = 323 mm
	PREZZO PRICE					
	profilo cromo, tappo cromo chrome profile, chrome cover	060.13U.00002	060.13F.00002	060.13E.00002	060.13G.00002	
	PREZZO PRICE					
Cavo 2000 mm 2000 mm cable		2 FRUTTI POWER + 1 USB 5V (2 PORTE A+A) + 2 RJ45 + 1 LED BLU 2 POWER SOCKETS + 1 USB 5V (2 PORT A+A) + 2 RJ45 + 1 LED blue				
CODICE CODE	profilo alluminio, tappo acciaio inox aluminum profile, inox cover	060.13U.00003	060.13F.00003	060.13E.00003	060.13G.00003	 L = 323 mm
	PREZZO PRICE					
	profilo cromo, tappo cromo chrome profile, chrome cover	060.13U.00004	060.13F.00004	060.13E.00004	060.13G.00004	
	PREZZO PRICE					
NOTE NOTES						
DIM. L x H x W 560 x 200 x 152 mm			PESO WEIGHT 2,00 kg	PZ PER SCATOLA PCS PER BOX 1	MOQ 4 PZ / PCS	CODICE DOGANALE CUSTOM CODE 85366990
CAVI INCLUSI CABLES INCLUDED 2 metri / meters		 				

VERSALUX